



PowerLogic PM5000 series

Basic multi-function meters

Technical datasheet





PowerLogic™ PM5000 Series meter

PowerLogic™ PM5100, PM5300 and PM5500 series

The PowerLogic™ PM5000 power meter is the ideal fit for cost management applications. It provides the measurement capabilities needed to allocate energy usage, perform tenant metering and sub-billing, pin-point energy savings, optimize equipment efficiency and utilization, and perform a high level assessment of the power quality of the electrical network.

In a single 96 x 96 mm unit, with a graphical display, all three phases, neutral and ground can be monitored simultaneously.

The bright, anti-glare display features large characters and powerful backlighting for easy reading even in extreme lighting conditions and viewing angles.

Easy to understand menus, text in 8 selectable languages, icons and graphics create a friendly environment to learn about your electrical network.

Highly accurate devices with global billing certifications.

Applications

Cost management: Cost saving opportunities becomes clear once you understand how and when your facility uses electricity. The PowerLogic™ PM5000 series meters are ideal for:

- **Sub billing / tenant metering:** allows a landlord, property management firm, condominium association, homeowners association, or other multi-tenant property to bill tenants for individual measured utility (electricity) usage. MID approved meters for billing applications across Europe.
- **Cost allocation:** allocate energy costs between different departments (HVAC, indoor and outdoor lighting, refrigeration, etc), different parts of an industrial process or different cost centres. Cost allocation systems can help you save money by making changes to your operation, better maintaining your equipment, taking advantage of pricing fluctuations, and managing your demand.

Network management: Improving reliability of the electrical network is key for success in any business. Monitoring values such as voltage levels, harmonic distortion and voltage unbalance will help you to ensure proper operation and maintenance of your electrical network and equipment. PowerLogic™ PM5000 series meters are the perfect tool for:

- **Basic Power Quality monitoring:** power quality phenomena can cause undesirable effects such as heating in transformers, capacitors, motors, generators and misoperation of electronic equipment and protection devices.
- **Min/ Max monitoring (with timestamp):** understanding when electrical parameters, such as voltage, current and power demand, reach maximum and minimum values will give you the insight to correctly maintain your electrical network and assure equipment will not be damaged.
- **Alarming:** alarms help you to be aware of any abnormal behavior on the electrical network in the moment it happens.
- **WAGES monitoring:** take advantage of the input metering on PM5000 meters to integrate measurements from 3rd party devices such as water, air, gas, electricity or steam, meters.

Main characteristics

Easy to install

Mounts using two clips, in standard cut out for DIN 96 x 96mm, no tools required. Compact meter with 72mm (77mm for PM5500) depth connectable up to 690 VL-L without voltage transformers for installations compliant with category III.

Easy to operate

Intuitive navigation with self-guided, language selectable menus, six lines, four concurrent values. Two LEDs on the meter face help the user confirm normal operation with a green LED - heartbeat/communications indicator, and the amber LED - customizable either for alarms or energy pulse outputs.

Easy circuit breaker monitoring and control

The PM5300 provides two relay outputs (high performance Form A type) with capability to command most of the circuit breaker coils directly. For Digital Inputs, monitored switches can be wired directly to the meter without external power supply. PM5500 series have 4 status inputs (digital) and 2 digital output (solid state) to use for WAGES monitoring, control and alarm annunciation.

Accurate energy measurement for precise cost allocation:

	PM5100	PM5300	PM5500
IEC 62053-22 (Active Energy)	Class 0.5S	Class 0.5S	Class 0.2S
IEC 62053-24 (Reactive Energy)	Class 2	Class 2	Class 1

Commercial reference numbers	
PM5100	METSEPM5100
PM5110	METSEPM5110
PM5111	METSEPM5111
PM5310	METSEPM5310
PM5320	METSEPM5320
PM5330	METSEPM5330
PM5331	METSEPM5331
PM5340	METSEPM5340
PM5341	METSEPM5341
PM5560	METSEPM5560
PM5561	METSEPM5561
PM5563	METSEPM5563



PB111768



PowerLogic™ PM5500 meter

Direct metering of neutral current

The PM5500 has a fourth CT for measuring neutral current. In demanding IT applications, where loads are non-linear (i.e. switching power supplies on computers/ servers), measuring neutral current is essential to avoid overload and resulting outage. In addition, the PM5500 provides a calculated ground current value, not available in meters with 3 CTs.

Power Quality analysis

The PM5000 offers Total Harmonic Distortion (THD/thd), Total Demand Distortion (TDD) measurements and individual harmonics (odd) magnitudes and angles for voltage and current:

	PM5100	PM5300	PM5500
Individual Harmonics	magnitudes up to 15th	magnitudes up to 31st	magnitudes & angles up to 63rd

These types of power quality parameters help to identify the source of harmonics that can harm transformers, capacitors, generators, motors and electronic equipment.

PB111770



PowerLogic™ PM5300 meter

Load management

Peak demands with time stamping are provided. Predicted demand values can be used in combination with alarms for basic load shedding applications.

Alarming with time stamping

A different combination of set point driven alarms and digital alarms with 1s time stamping are available in the PM5000 family:

	PM5100	PM5300	PM5500
Set point driven alarms	29	29	29
Unary	4	4	4
Digital	-	2	4
Boolean / Logic	-	-	10
Custom defined	-	-	5

Alarms can be visualized as Active (the ones that have picked up and did not drop out yet) or Historical (the ones that happened in the past).

Alarms can be programmed and combined to trigger digital outputs and mechanical relays (PM5300).

The PM5000 series keeps an alarm log with the active and historical alarms with date and time stamping.

PB111768



PowerLogic™ PM5100 meter

Load timer

A load timer can be set to count load running hours based on a minimum current withdraw, adjustable to monitor and advise maintenance requirements on the load.

High Performance and accuracy

IEC 61557-12 Performance measuring and monitoring devices (PMD) Defines the performance expectation based on classes. It defines the allowable error in the class for real and reactive power and energy, frequency, current, voltage, power factor, voltage unbalance, voltage and current harmonics (odds), voltage THD, current THD, as well as ratings for temperature, relative humidity, altitude, start-up current and safety. It makes compliant meters readings comparable - they will measure the same values when connected to the same load.

Meets IEC 61557-12* PMD/[SD|SS]/K70/0.5 for PM5100 and PM5300

Meets IEC 61557-12* PMD/[SD|SS]/K70/0.2 for PM5500



Certified according to MID Directive, Annex "B" + Annex "D" for legal metrology relevant to active electrical energy meters (see Annex MI-003 of MID). Can be used for fiscal (legal) metrology.

Legal billing compliance

MID compliance is compulsory for billing applications across Europe. In addition to billing applications, for facility managers responsible for energy cost MID means same level of quality as a billing meter.

MID ready compliance, EN50470-1/3 – Class C

*Pending approval.



General	PM5100	PM5300	PM5500
Use on LV and MV systems		■	
Basic metering with THD and min/max readings		■	
Instantaneous rms values			
Current per phase, neutral and ground (PM5500)		■	
Voltage Total, per phase L-L and L-N		■	
Frequency		■	
Real, reactive, and apparent power Total and per phase		Signed, Four Quadrant	
True Power Factor Total and per phase		Signed, Four Quadrant	
Displacement PF Total and per phase		Signed, Four Quadrant	
% Unbalanced I, VL-N, VL-L		■	
Direct monitoring of neutral current			■
Energy values*			
Accumulated Active, Reactive and Apparent Energy	Received/Delivered; Net and absolute; Time Counters		
Demand values*			
Current average	Present, Last, Predicted, Peak, and Peak Date Time		
Active power	Present, Last, Predicted, Peak, and Peak Date Time		
Reactive power	Present, Last, Predicted, Peak, and Peak Date Time		
Apparent power	Present, Last, Predicted, Peak, and Peak Date Time		
Peak demand with time stamping D/T for current and powers		■	
Demand calculation Sliding, fixed and rolling block, thermal methods		■	
Synchronization of the measurement window to input, communication command or internal clock		■	
Settable Demand intervals		■	
Demand calculation for Pulse input (WAGES)			■
Other measurements*			
I/O timer		■	
Operating timer		■	
Load timer		■	
Alarm counters and alarm logs		■	
Power quality measurements			
THD, thd (Total Harmonic Distortion) I, VLN, VLL per phase		I, VLN, VLL	
TDD (Total Demand Distortion)		■	
Individual harmonics (odds)	15th	31st	63rd
Neutral Current metering with ground current calculation			■
Data recording			
Min/max of instantaneous values, plus phase identification*		■	
Alarms with 1s timestamping*		■	
Data logging		2 fixed parameters kWh and kVAh with configurable interval and duration (e.g. 2 parameters for 60 days at 15 minutes interval)	Up to 14 selectable parameters with configurable interval and duration (e.g. 6 parameters for 90 days at 15 minutes interval)
Memory capacity		256 kB	1.1 MB
Min/max log	■	■	■
Maintenance, alarm and event logs		■	■
Customizable data logs			■
Inputs / Outputs / Mechanical Relays			
Digital inputs		2 (SI1, SI2)	4 (SI1, SI2, SI3, SI4) with WAGES support
Digital outputs	1 (kWh only)	2 (configurable)	
Form A Relay outputs		2	
Timestamp resolution in seconds		1	
Whetting voltage		■	

*Stored in non-volatile memory



PM5000 Series

Functions and characteristics (cont.)

Electrical characteristics*		PM5100	PM5300	PM5500		
Type of measurement: True rms on three-phase (3P, 3P + N), zero blind		64 samples per cycle		128 samples per cycle		
Measurement accuracy	IEC 61557-12	PMD/[SD]SS]/K70/0.5		PMD/[SD]SS]/K70/0.2		
	Active Energy	Class 0.5S as per IEC 62053-22		Class 0.2S as per IEC 62053-22		
	Reactive Energy	Class 2S as per IEC62053-24		Class 1S as per IEC62053-24		
	Active Energy	±0.5%		±0.2%		
	Reactive Energy	±2%		±1%		
	Active Power	Class 0.5 as per IEC 61557-12		Class 0.2 as per IEC 61557-12		
	Apparent Power	Class 0.5 as per IEC 61557-12				
	Current, Phase	Class 0.5 as per IEC 61557-12		±0.15%		
	Voltage, L-N	Class 0.5 as per IEC 61557-12		±0.1%		
	Frequency	±0.05%				
MID Directive EN50470-1, EN50470-3		Annex B and Annex D (Optional model references) Class C				
Input-voltage (up to 1.0 MV AC max, with voltage transformer)	Nominal Measured Voltage range	20 V L-N / 35 V L-L to 400 V L-N / 690 V L-L absolute range 35 V L-L to 760 V L-L		20 V L-N / 20 V L-L to 400 V L-N / 690 V L-L absolute range 20 V L-L to 828 V L-L		
	Impedance	5 M Ω				
	F nom	50 or 60 Hz ±5%		50 or 60 Hz ±10%		
Input-current	I nom	1 A or 5 A				
	Measured Amps with over range and Crest Factor	Starting current: 5mA Operating range: 50mA to 8.5A		Starting current: 5mA Operating range: 50 mA to 10 A		
	Withstand	Continuous 20A, 10s/hr 50A, 1s/hr 500A				
	Impedance	< 0.3 mΩ				
	F nom	50 or 60 Hz ±5%		50 or 60 Hz ±10%		
AC control power	Burden	<0.026VA at 8.5A				
	Operating range	100 - 277 V AC L-N / 415 V L-L +/-10% CAT III 300V class per IEC 61010		100-480 V AC ±10% CAT III 600V class per IEC 61010		
	Burden	<5 W, 11 VA at 415V L-L		<5W/16.0 VA at 480V AC		
	Frequency	45 to 65 Hz				
Ride-through time	80 mS typical at 120V AC and maximum burden. 100 mS typical at 230 V AC and maximum burden 100 mS typical at 415 V AC and maximum burden		35 ms typical at 120 V L-N and maximum burden 129 ms typical at 230 V L-N and maximum burden			
DC control power	Operating range	125-250 V DC ±20%				
	Burden	<4 W at 250 V DC		typical 3.1W at 125 V DC, max. 5W		
	Ride-through time	50 mS typical at 125 V DC and maximum burden				
Outputs	Relay	Max output frequency	0.5 Hz maximum (1 second ON / 1 second OFF - minimum times)			
		Switching current	250 V AC at 8.0 Amps, 25 k cycles, resistive 30 V DC at 2.0 Amps, 75 k cycles, resistive 30 V DC at 5.0 Amps, 12.5 k cycles, resistive			
		Isolation	2.5 kV rms			
	Digital outputs		1	2	2	
		Max load voltage	40 V DC		30 V AC / 60 V DC	
		Max load current	20 mA		125 mA	
		On Resistance	50 Ω max		8 Ω	
		Meter constant	from 1 to 9,999,999 pulses per kWh			
		Pulse width for Digital Output	50% duty cycle			
		Pulse frequency for Digital Output	25 Hz max.			
		Leakage current	0.03 micro Amps		1 micro Amps	
		Isolation	5 kV rms		2.5 kV rms	
		Optical outputs	Pulse width (LED)	200 ms		
			Pulse frequency	50 Hz. max.		2.5 kHz. max
			Meter constant	from 1 to 9,999,999 pulses per kWh		



Electrical characteristics* (cont'd)		PM5100	PM5300	PM5500
Status Inputs	ON Voltage		18.5 to 36 V DC	30 V AC / 60 V DC max
	OFF Voltage		0 to 4 V DC	
	Input Resistance		110 k Ω	100 k Ω
	Maximum Frequency		2 Hz (T ON min = T OFF min = 250 ms)	25 Hz (T ON min = T OFF min = 20 ms)
	Response Time		20 ms	10 ms
	Opto Isolation		5 kV rms	2.5 kV rms
	Whetting output		24 V DC/ 8mA max	
	Input Burden		2mA @24V DC	2 mA @ 24 V AC/DC
Mechanical characteristics				
Product weight		380 g	430 g	450 g
IP degree of protection (IEC 60529)		IP52 front display, IP30 meter body		
Dimensions W x H x D [protrusion from cabinet] **		96 x 96 x 72mm (77mm for PM5500) (depth of meter from housing mounting flange) [13mm]		
Mounting position **		Vertical		
Panel thickness		6 mm maximum		
Environmental characteristics				
Operating temperature	Meter	-25 °C to 70 °C		
	Display (Display functions to -25° with reduced performance)	-25 °C to +70 °C		
Storage temp.		-40 °C to +85 °C		
Humidity range		5 to 95 % RH at 50 °C (non-condensing)		
Pollution degree		2		
Altitude		2000 m CAT III / 3000 m CAT II		3000 m max. CAT III
Electromagnetic compatibility***				
Harmonic current emissions		IEC 61000-3-2		
Flicker emissions		IEC 61000-3-3		
Electrostatic discharge		IEC 61000-4-2		
Immunity to radiated fields		IEC 61000-4-3		
Immunity to fast transients		IEC 61000-4-4		
Immunity to surge		IEC 61000-4-5		
Conducted immunity 150kHz to 80MHz		IEC 61000-4-6		
Immunity to magnetic fields		IEC 61000-4-8		
Immunity to voltage dips		IEC 61000-4-11		
Radiated emissions		FCC part 15, EN 55022 Class B		
Conducted emissions		FCC part 15, EN 55022 Class B		

*Electrical Characteristics still under verification at time of printing of the catalogue, may be subject to change.

** PM5563 is DIN mounted

*** Tests are conducted as per IEC 61557-12 (IEC 61326-1), 62052-11 and EN50470



Safety	PM5100	PM5300	PM5500
Europe	CE, as per IEC 61010-1 Ed. 3, IEC 62052-11 & IEC61557-12		
U.S. and Canada	cULus as per UL61010-1 (3rd Edition)		
Measurement category (Voltage and Current inputs)	CAT III up to 400 V L-N / 690 V L-L		
Dielectric	As per IEC/UL 61010-1 Ed. 3		
Protective Class	II, Double insulated for user accessible parts		
Communication			
RS 485 port Modbus RTU, Modbus ASCII (7 or 8 bit), JBUS	2-Wire, 9600, 19200 or 38400 baud, Parity - Even, Odd, None, 1 stop bit if parity Odd or Even, 2 stop bits if None; (Optional in PM51x and PM53x)		
Ethernet port: 10/100 Mbps; Modbus TCP/IP		1 Optional	2 (for daisy chain only, one IP address)
Firmware and language file update	Meter firmware update via the communication ports		
Isolation	2.5 kVrms, double insulated		
Human machine interface			
Display type	Monochrome Graphics LCD		
Resolution	128 x 128		
Backlight	White LED		
Viewable area (W x H)	67 x 62.5 mm		
Keypad	4-button		
Indicator Heartbeat / Comm activity	Green LED		
Energy pulse output / Active alarm indication (configurable)	Optical, amber LED		
Wavelength	590 to 635 nm		
Maximum pulse rate	2.5 kHz		

Features and Options	PM5100		PM5300				PM5500	
	PM5100	PM5110	PM5310	PM5320	PM5330	PM5340	PM5560	PM5563
Installation								
Fast installation, panel mount with integrated display	■	■	■	■	■	■	■	-
Fast installation, DIN rail mountable	-	-	-	-	-	-	-	■
Accuracy	Cl 0.5S	Cl 0.5S	Cl 0.5S	Cl 0.5S	Cl 0.5S	Cl 0.5S	Cl 0.2S	Cl 0.2S
Display								
Backlit LCD, multilingual, bar graphs, 6 lines, 4 concurrent values	■	■	■	■	■	■	■	■
Power and energy metering								
3-phase voltage, current, power, demand, energy, frequency, power factor	■	■	■	■	■	■	■	■
Multi-tariff	-	-	4	4	4	4	8	8
Power quality analysis								
THD, thd, TDD	■	■	■	■	■	■	■	■
Harmonics, individual (odd) up to	15th	15th	31st	31st	31st	31st	63rd	63rd
I/Os and relays								
I/Os	1DO	1DO	2DI/2DO	2DI/2DO	2DI/2DO	2DI/2DO	4DI/2DO	4DI/2DO
Relays	0	0	0	0	2	√2	0	0
Alarms and control								
Alarms	33	33	35	35	35	35	52	52
Set point response time, seconds	1	1	1	1	1	1	1	1
Single and multi-condition alarms	-	-	■	■	■	■	■	■
Boolean alarm logic	-	-	-	-	-	-	■	■
Communications								
Serial ports with modbus protocol	-	1	1	-	1	-	1	1
Ethernet port with Modbus TCP protocol	-	-	-	1	-	1	2**	2**
MID ready compliance, EN50470-1/3, Annex B and Annex D Class C		PM5111			PM5331	PM5341	PM5561	

** 2 Ethernet ports for daisy chain, one IP address.

PM5000 Series meter flush mounting*

PB111276

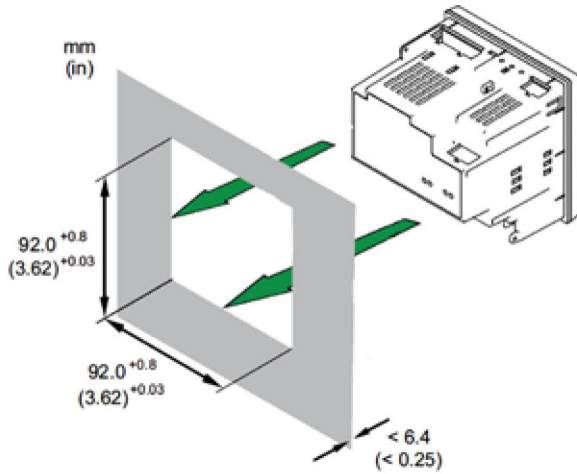

PM5000 Series meter dimensions

PB111279

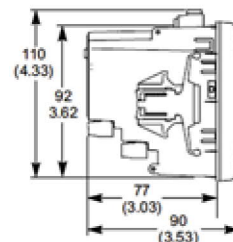
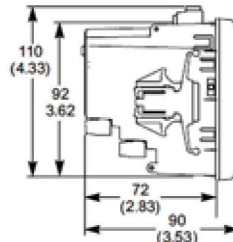
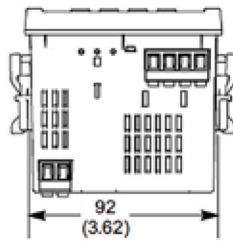
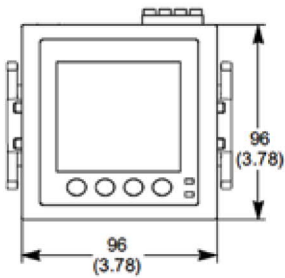

PM5100 / PM5300

PM5500

PB111278

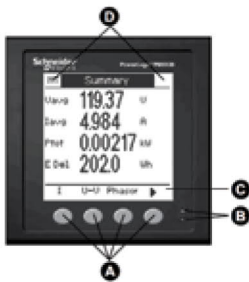

PM5000 meter parts

- A Menu selection buttons
- B LED indicators
- C Navigation or menu selections
- D Maintenance and alarm notification area

PB111277

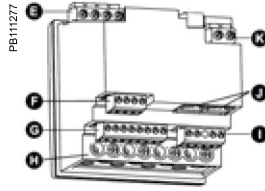

PM5500

PM5500 meter parts

- E Voltage inputs
- F RS-485 comms
- G Digital inputs
- H Current inputs
- I Digital outputs
- J Ethernet ports
- K Control power

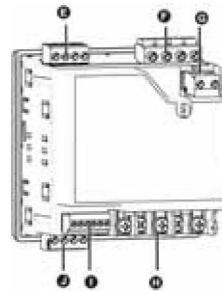

PM5100 / PM5300 meter parts

- E Relay output (PM5300 only)
- F Voltage inputs
- G Control power
- H Current inputs
- I Status inputs/digital outputs
- J Communications port: Ethernet (PM5300 only) or RS-485

** PM5563 is DIN mounted

Please see the **Installation Guide** for accurate and complete information on the installation of this product.



Schneider Electric 施耐德電機授權經銷商
東技企業股份有限公司
普得企業股份有限公司

總公司：台北市內湖區行愛路68號6樓
電話：(02)8791-8588
傳真：(02)8791-9588
E-mail: toyotech@ms37.hinet.net

中辦處：(04)2296-9388
高辦處：(07)227-2133
網址：www.toyotech.com.tw

Schneider Electric Industries SAS
35, Rue Joseph Monier,
CS 30323
F - 92506 Rueil Malmaison Cedex

RCS Nanterre 954 503 439
Capital social 896 313 776
www.schneider-electric.com

As standards, specifications and designs develop from time to time, please ask for confirmation of the information given in this document.



This document has been printed on recycled paper

Design: Schneider Electric
Photos: Schneider Electric

